

PLANTA 01  
ESCALA: RELATIVA

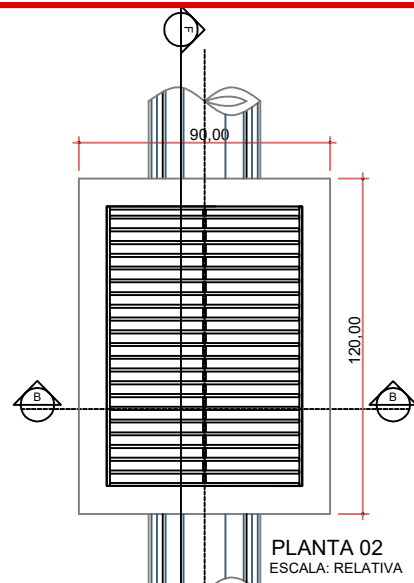

PLANTA 02  
ESCALA: RELATIVA

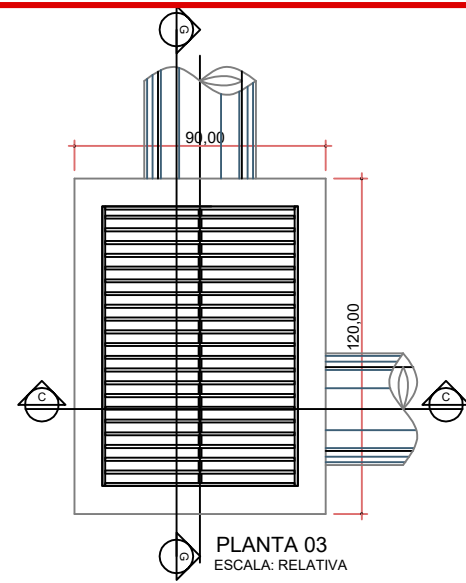

PLANTA 03  
ESCALA: RELATIVA

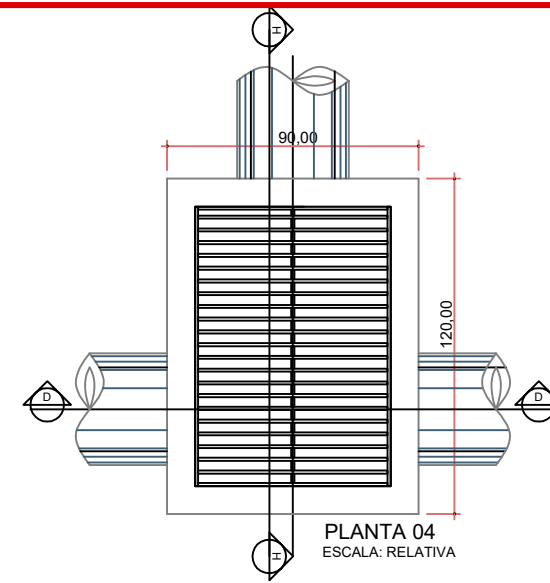

PLANTA 04  
ESCALA: RELATIVA

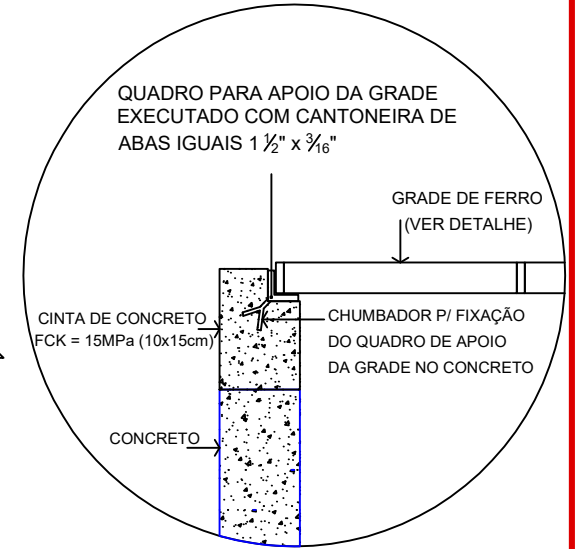

DETALHE APOIO DA GRADE  
ESCALA: RELATIVA

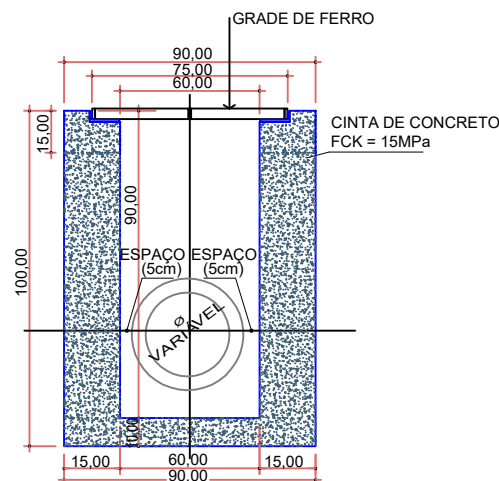

CORTE AA  
ESCALA: RELATIVA

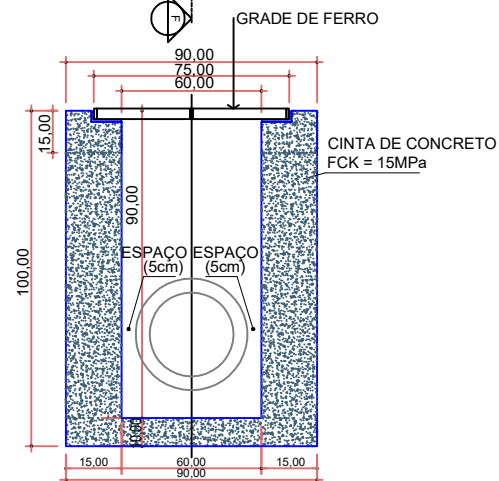

CORTE BB  
ESCALA: RELATIVA

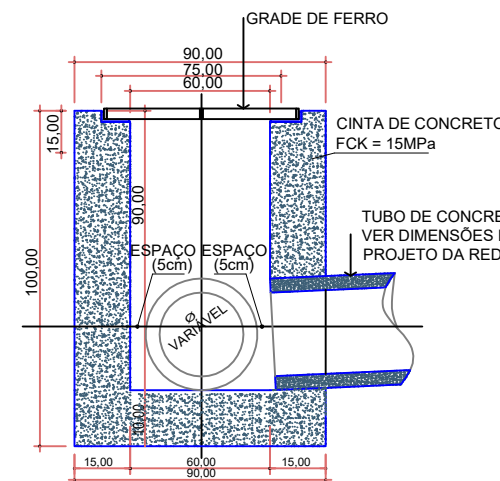

CORTE CC  
ESCALA: RELATIVA

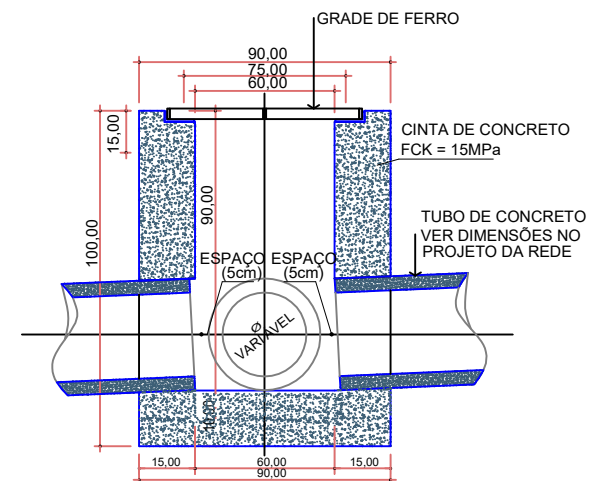

CORTE DD  
ESCALA: RELATIVA

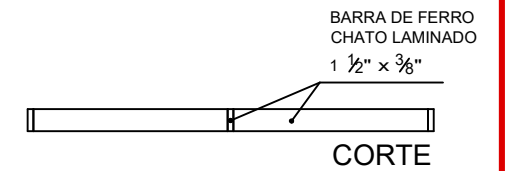

CORTE

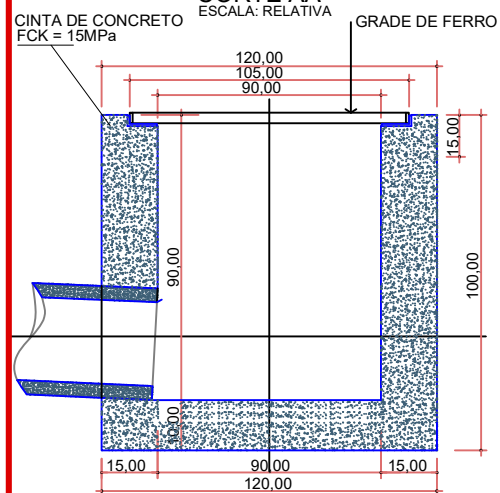

CORTE EE  
ESCALA: RELATIVA

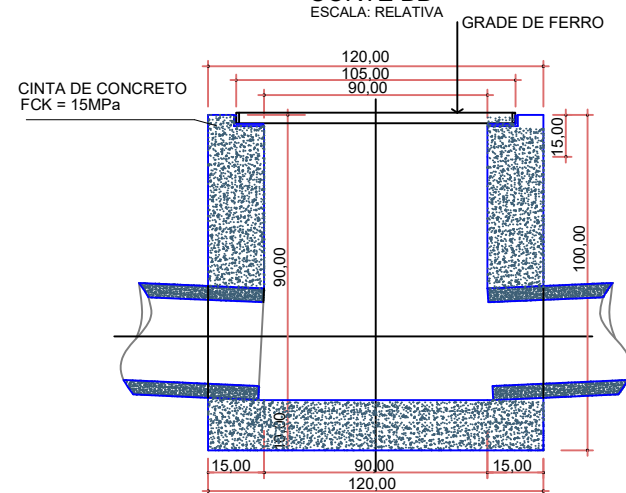

CORTE FF  
ESCALA: RELATIVA

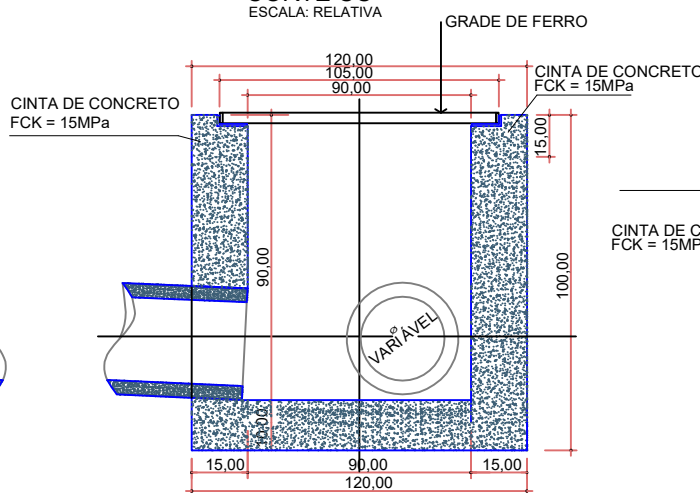

CORTE GG  
ESCALA: RELATIVA

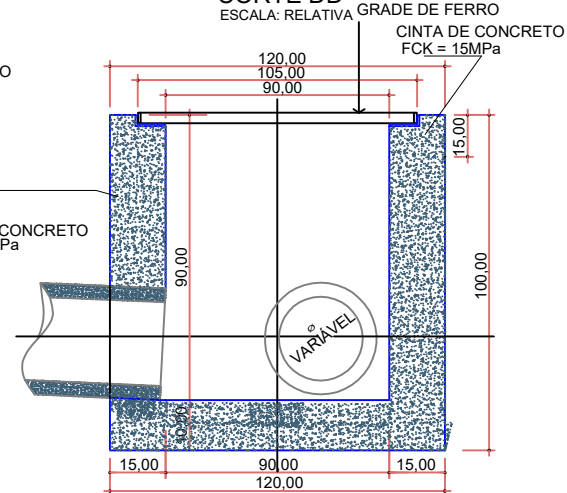

CORTE HH  
ESCALA: RELATIVA

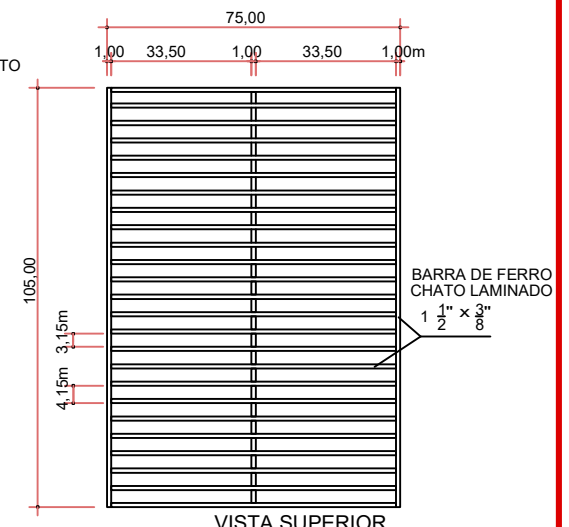

VISTA SUPERIOR

DETALHE DA GRADE  
SEM ESCALA DEFINIDA



RESPONSÁVEL TÉCNICO

PREFEITO MUNICIPAL

MUNICÍPIO DE CATANDUVAS - SC

Obra:  
PROJETO DE PAVIMENTAÇÃO EM ASFALTO C.A.U.Q.  
RUA ERY GOMES BITTENCOURT

Projeto:  
DENIR NARCIZO ZULIAN - ENG. CIVIL - CREA/SC 50.805-8  
MICHEL ALBERTI - ENG. CIVIL - CREA/SC 80.032-6  
ANA JÚLIA UNGERICH - ENG. CIVIL-CREA/SC 105.295-8

Desenho:  
EDSON ABATTI

Data:  
JUNHO DE 2018

Escala:  
1/ 1.000

Serviço:  
DETALHES DRENAGEM

Trecho:  
ESTACA O.P.P - 8+15.734 m

Prancha:

02/02