

PLANTA 01
Escala 1/10

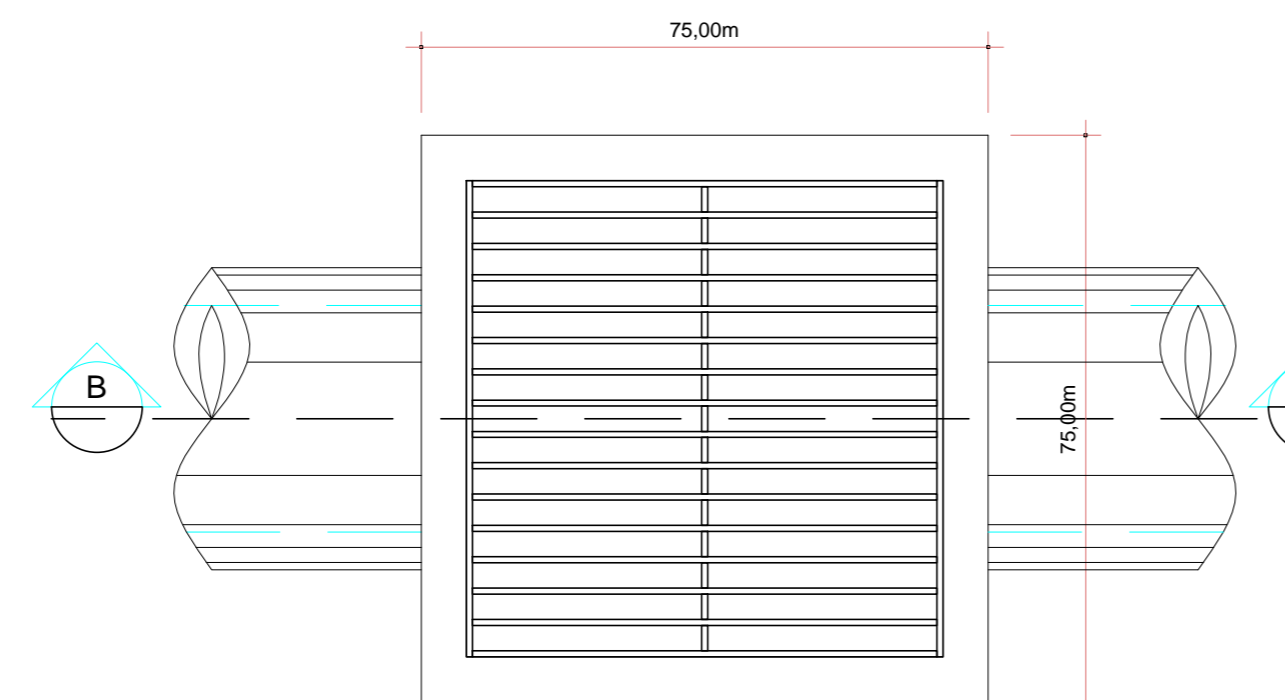

PLANTA 02
Escala 1/10

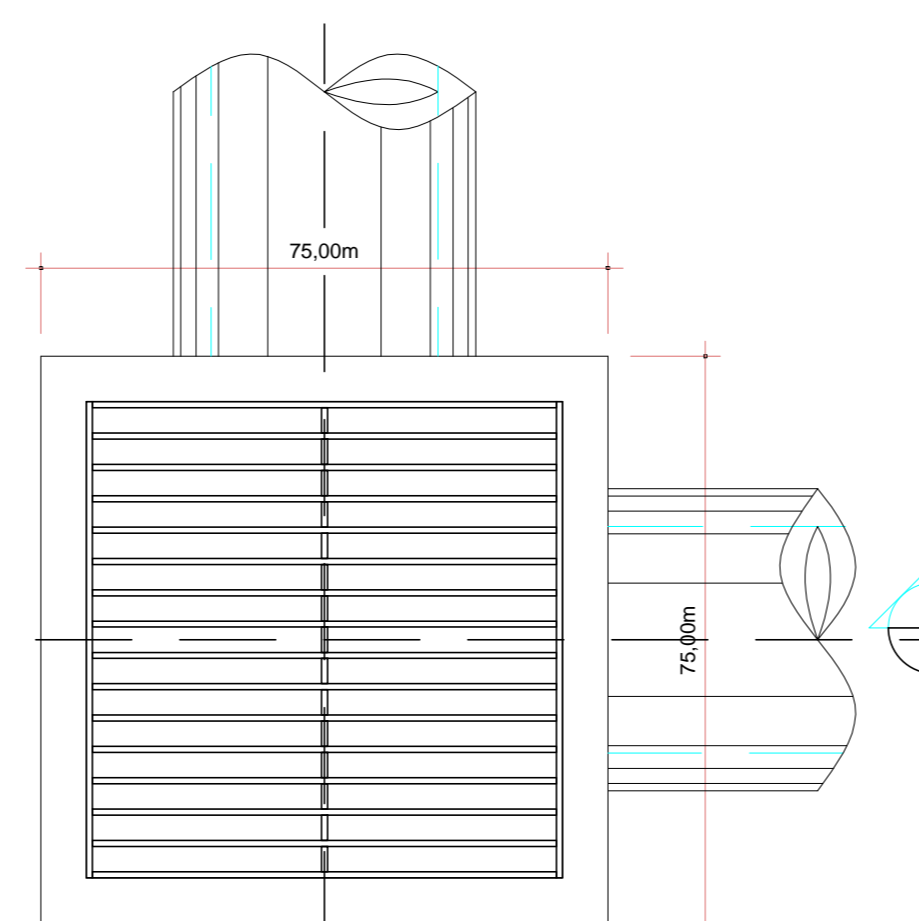

PLANTA 03
Escala 1/10

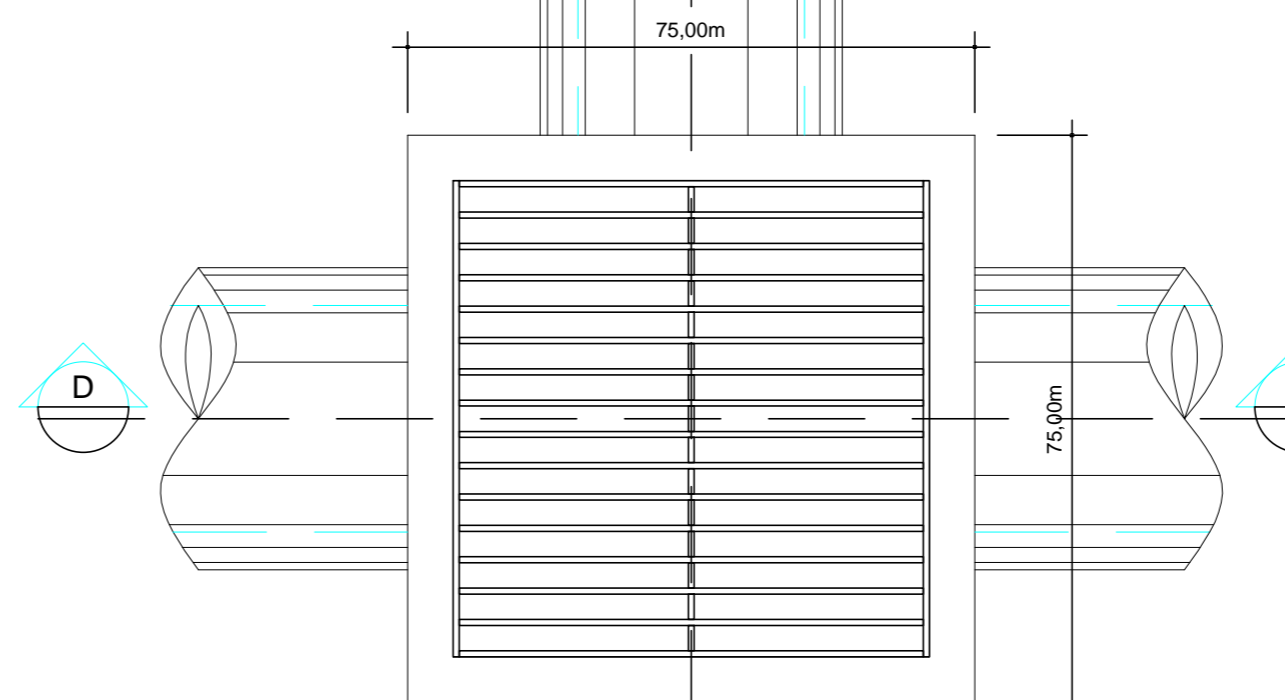

PLANTA 04
Escala 1/10

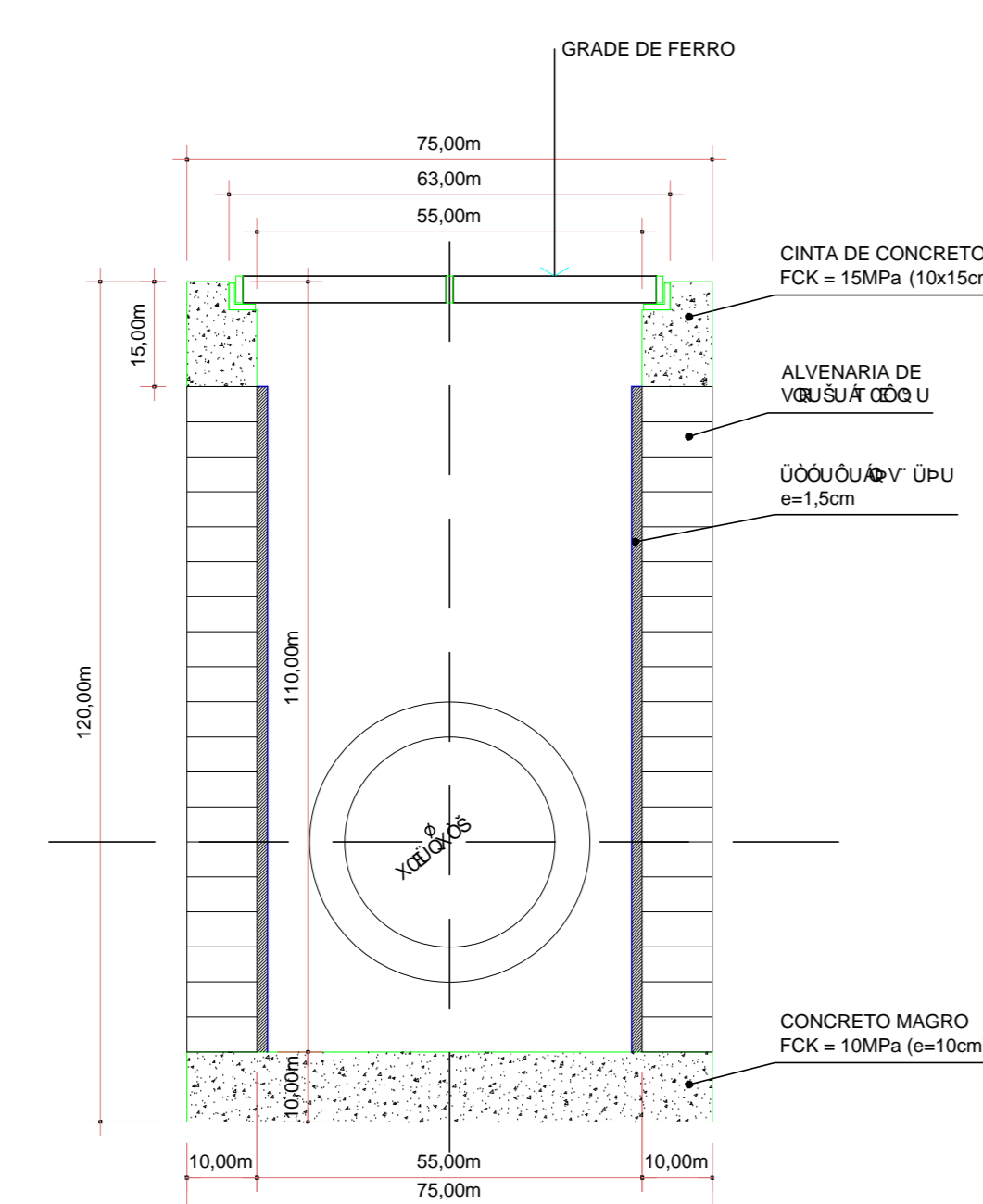

CORTE AA
Escala 1/10

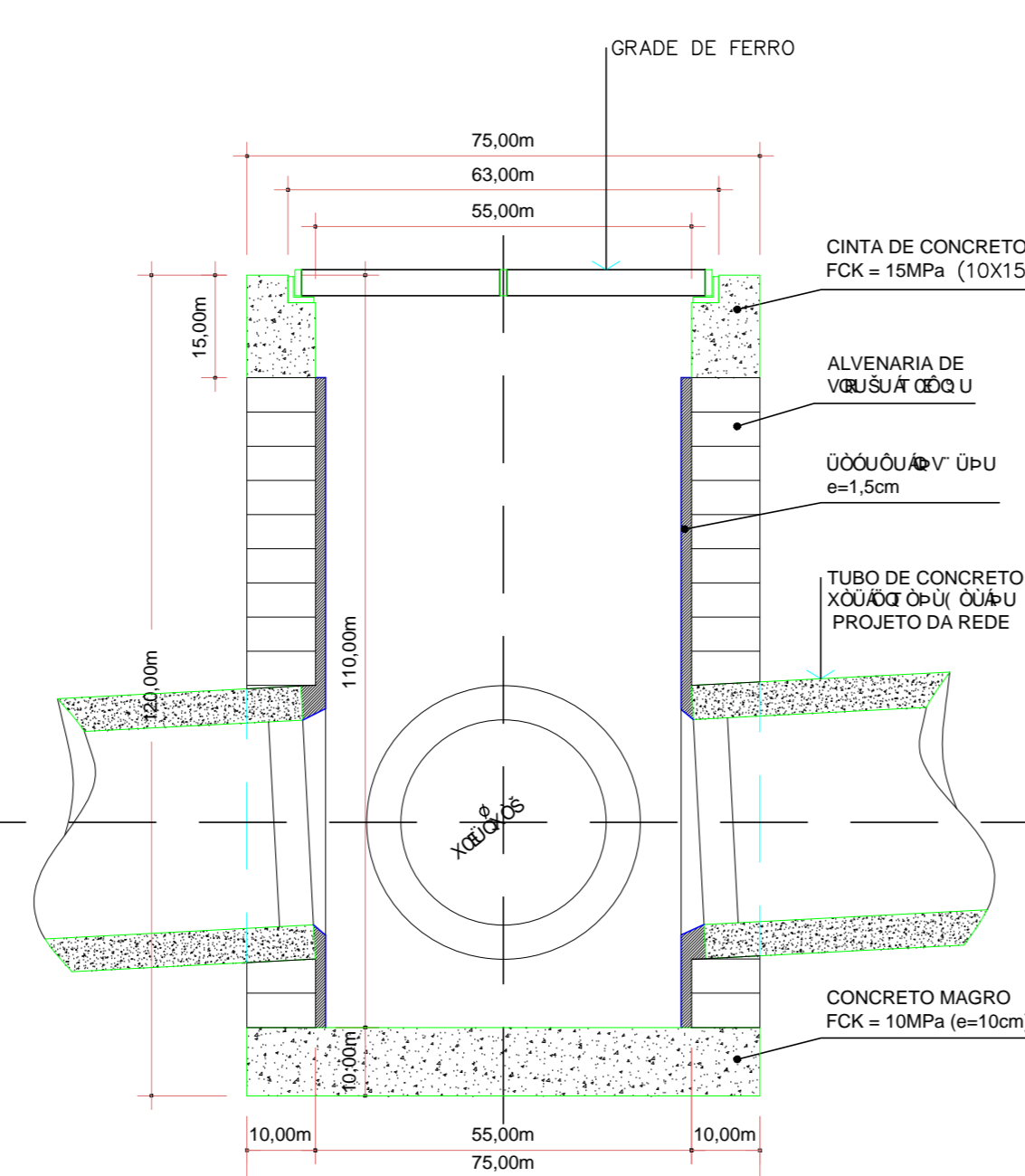

CORTE BB
Escala 1/10

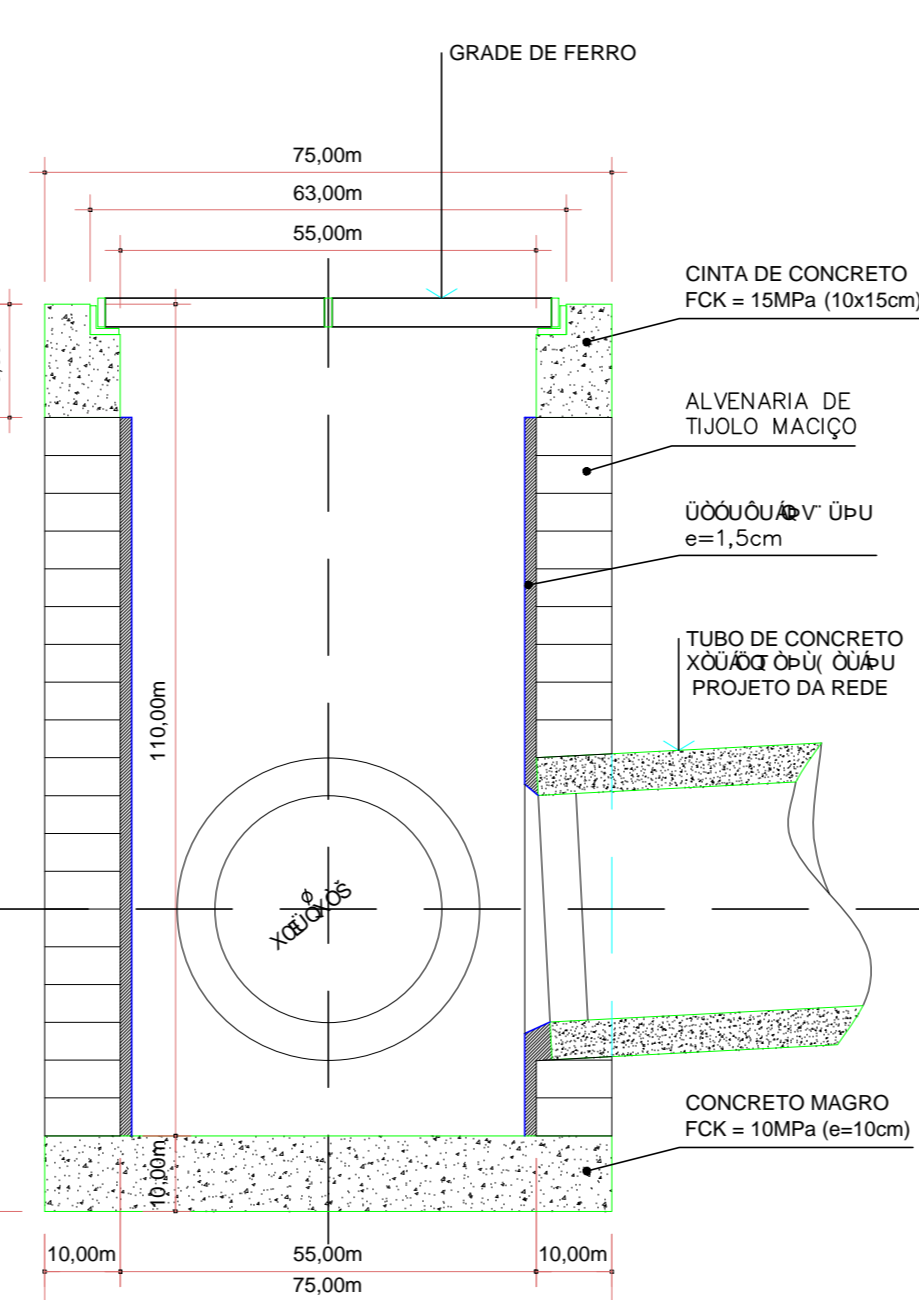

CORTE CC
Escala 1/10

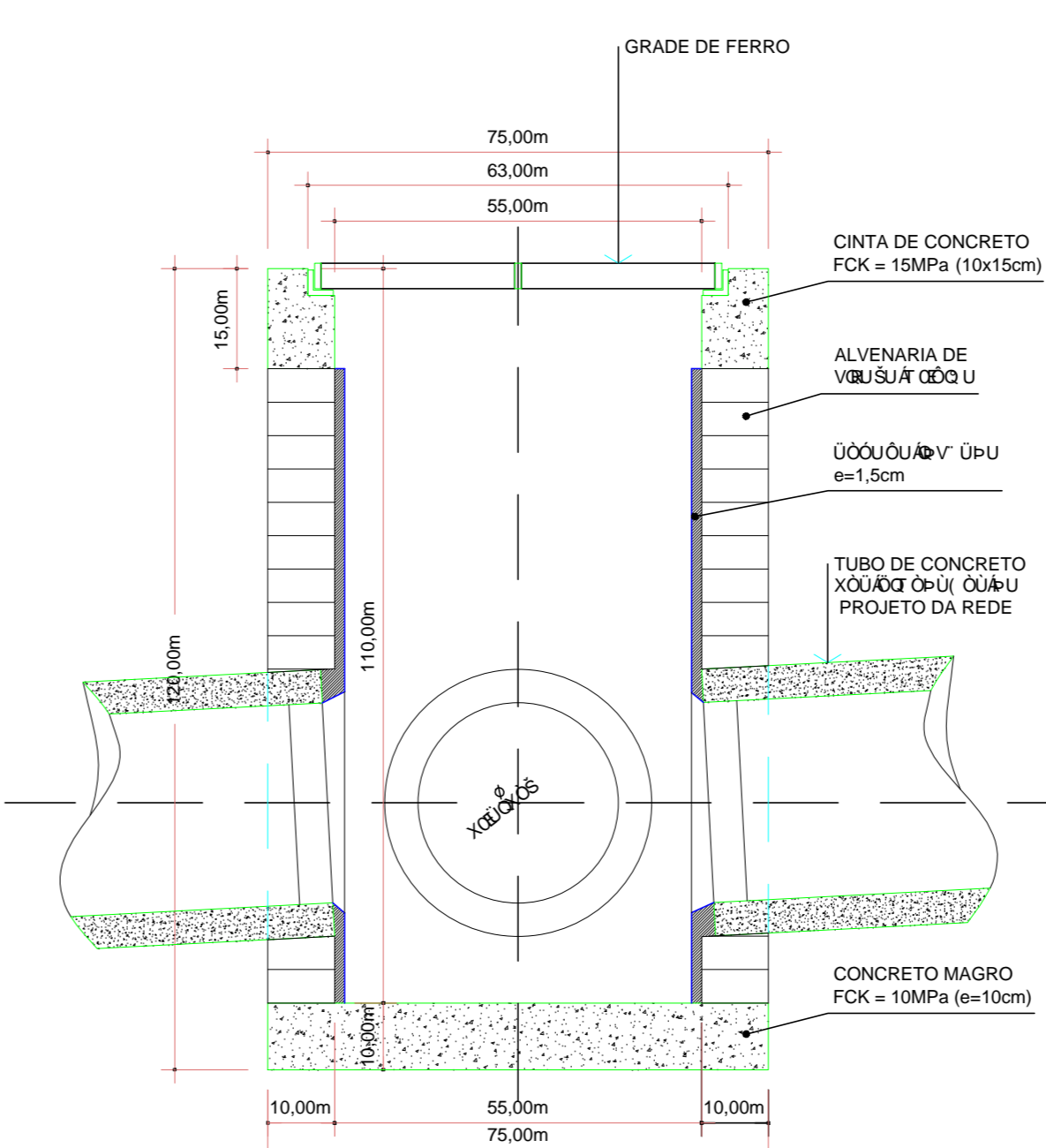

CORTE DD
Escala 1/10

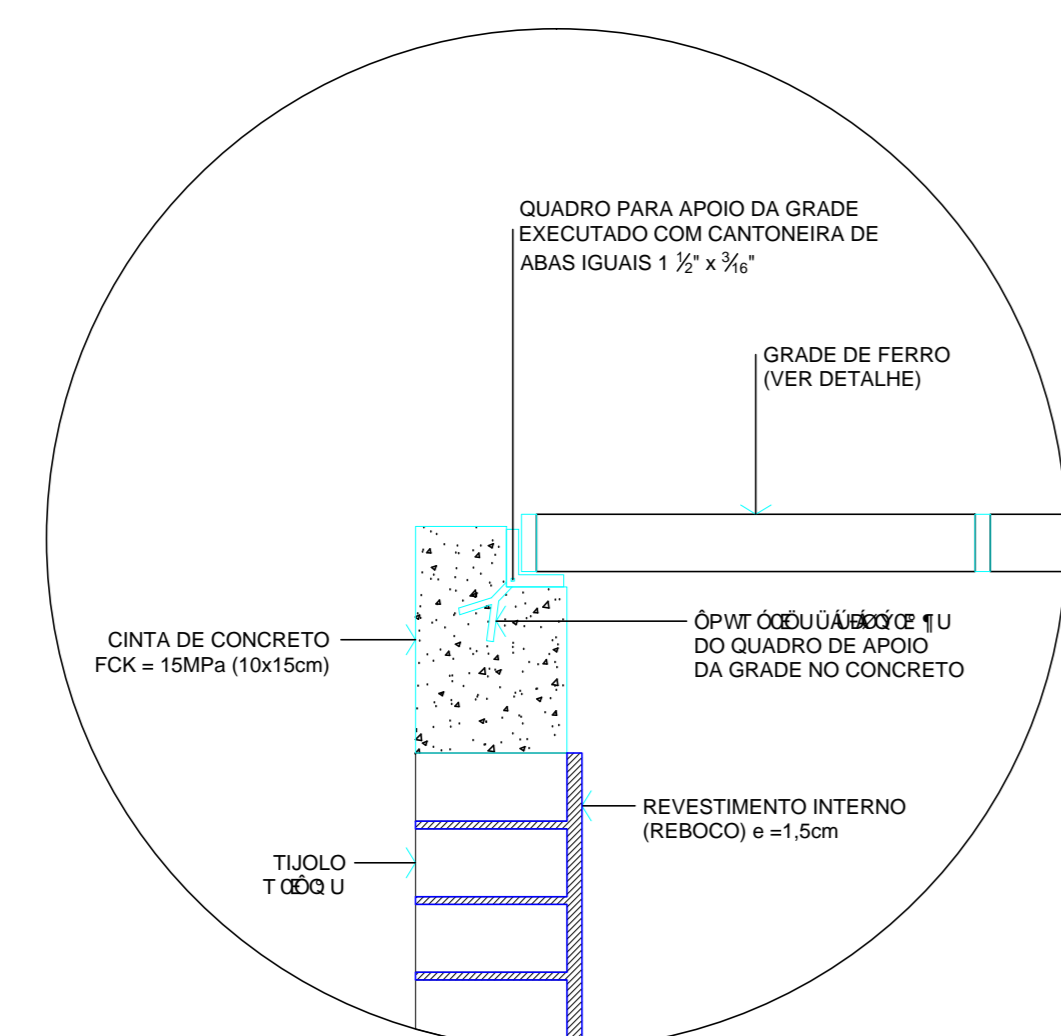

DETALHE APOIO DA GRADE
Escala 1/5

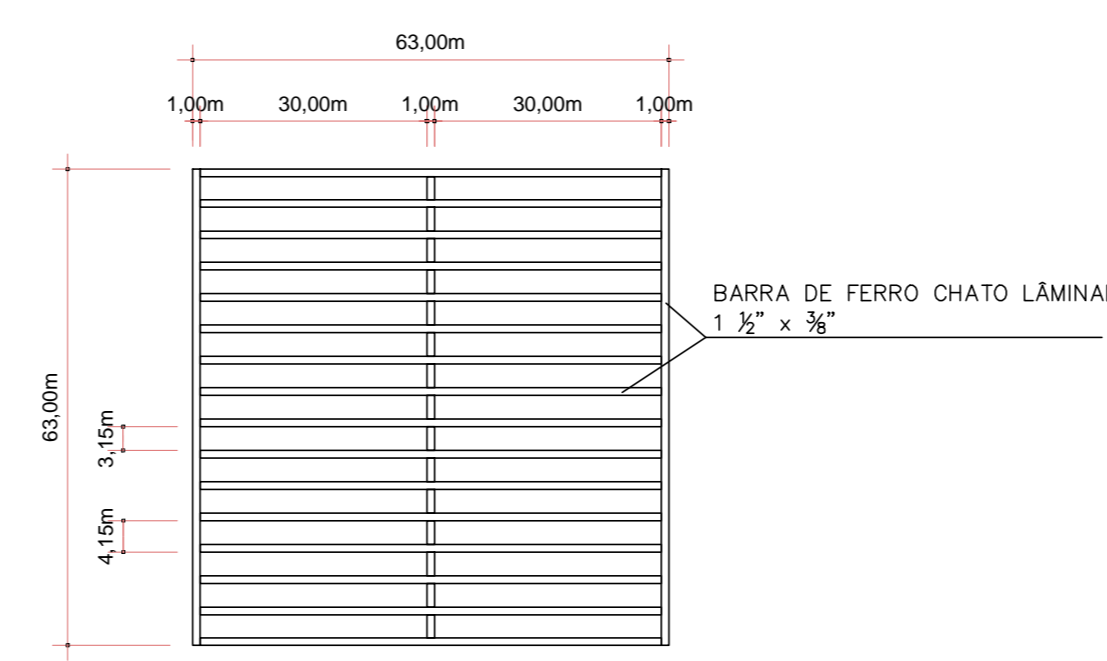

DETALHE DA GRADE
Escala 1/10

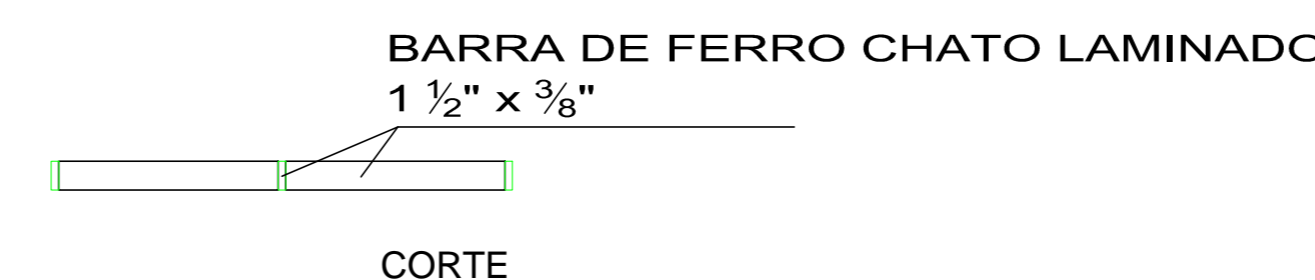

Associação dos Municípios do Noroeste Catarinense

Rua Roberto Tompazski, 27 - Joinville - Tel: 49-3502-2800 Fax: 3502-0200 www.ammoc.org.br e-mail: ammoc@ammoc.org.br - CEP: 89200-000

TÍTULO: UOΛΟΔΟΣΕ/ΕΘΝΚΕΛΕΛΙΟ

Local da Obra: RUA 7 DE ABRIL

Projeto: GISA APARECIDA GIACOMINI

Prêmio: 02/02

Desenho: EDSON ABATTI

Escala: 1/10

Data: 02/02

Assinatura Profissional

Projeto: DRE. 02/02

Desenho: EDSON ABATTI

Data: 02/02

Assinatura Profissional